

Introduced by: City Manager Nathan Mai-Lombardo

AN ORDINANCE AUTHORIZING THE CITY MANAGER TO EXECUTE AN AGREEMENT WITH MIRACLE RECREATION ACCORDING TO BID #940 – PLAYGROUND EQUIPMENT

NOW, THEREFORE, BE IT ORDAINED BY THE CITY COUNCIL OF THE CITY OF BERKELEY, MISSOURI, AS FOLLOWS:

Section 1. The City Manager is hereby authorized to execute an Agreement according to Bid #940, Parks Playground Replacement Project with Miracle Recreation.

Section 2. The agreement is attached and hereby incorporated herein and made a part of this ordinance, as if fully set out herein.

Section 3. This Ordinance shall be in full force and effect from and after its date of passage.

1st Reading this 06th day of November 2023

2nd Reading this 06th day of November 2023

3rd Reading, PASSED and APPROVED, this 20th day of November 2023

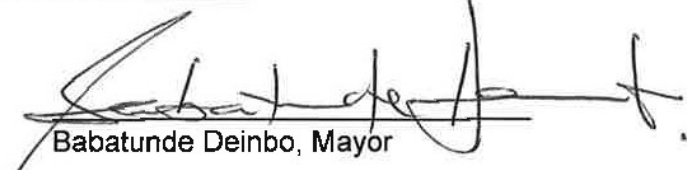
Babatunde Deinbo, Mayor

ATTEST:

Deanna L. Jones, City Clerk

Approved as to Form:
Donnell Smith, City Attorney

Final Roll Call:

Councilwoman Verges	Aye <u>X</u> Nay ___ Absent ___ Abstain ___
Councilwoman Williams	Aye <u>X</u> Nay ___ Absent ___ Abstain ___
Councilman Hoskins	Aye ___ Nay <u>X</u> Absent ___ Abstain ___
Councilwoman Anthony	Aye <u>X</u> Nay ___ Absent ___ Abstain ___
Councilman Hindeleh	Aye <u>X</u> Nay ___ Absent ___ Abstain ___
Councilwoman-at-Large Crawford-Graham	Aye <u>X</u> Nay ___ Absent ___ Abstain ___
Mayor Deinbo	Aye <u>X</u> Nay ___ Absent ___ Abstain ___



MIRACLE RECREATION C/O
HUTCHINSON RECREATION & DESIGN
1000 EDGEWATER PT STE 101
LAKE SAINT LOUIS, MO 63367

Miracle A

Name/Address		
City of Berkeley		
VOLUNTARY ALTERNATE		
Date	Quotation #	REP
10/12/23	12986	

Quantity	Description	Terms
	MIRACLE IS MADE IN MISSOURI (3) AGE 5-12 FITNESS PLAYGROUNDS (2) CUSTOM 2-5 AGE PLAYGROUNDS (3) CUSTOM 5-12 AGE PLAYGROUNDS (2) MR0930SW. 2 ARCH SWINGS 2 SEATS PER SWING FREIGHT INSTALLATION OF EQUIPMENT W/PREVAILING WAGES. CITY TO HAVE SITES TO DIRT BASE BEFORE INSTALL CREW ARRIVES. CITY TO INSTALL SAFETY SURFACING AFTER INSTALL COMPLETE. PERFORMANCE BOND UNLOAD EQUIPMENT ADD \$1,250.00 IF REQUIRED. STORAGE BY CITY. INSTALL CREW CAN TRANSPORT EQUIPMENT TO SITES AT NO CHARGE FOR INSTALL. **WE ARE SCHEDULING INSTALLATIONS IN SPRING 2024 NOW. Tax Exempt	Total 165,000.00T 0.00

The acceptance signature below serves as authorization to order the items quoted & indicates acceptance of the listed prices and terms enclosed. Signature will not substitute for a Purchase Order.

Total **\$165,000.00**

Unloading, storage and installation of equipment upon arrival is not included in above pricing unless specifically noted on quote.

Acceptance Signature: 

Printed Name: Nathan Mai-Lombardo, City Manager

Phone: (800) 848.5616

www.hutchinson-recreation.com

Fax: (314) 332.2877

NOTE: Purchase orders & checks for equipment should be made out to Miracle Recreation.

Hutchinson Recreation & Design - Terms and Conditions

Page 1 of 4 (Terms and Conditions & Proposal Facts)

The quotation, terms and conditions, and proposal facts must be attached and included as an exhibit to any contract, which is entered into as a result of this quotation. Failure to do so will result in such contract being returned unsigned until these items have been included, thus delaying the processing of your order.

PLEASE NOTE FOR ALL QUOTES / BIDS – INSTALLATION IS NOT INCLUDED UNLESS SPECIFICALLY NOTED ON THE QUOTE / BID.

Equipment orders with Installation service: Continuous access will be provided to the installation crew for heavy equipment traffic without obstruction for delivery and installation of equipment, safety surfacing, and any other materials or furnishing provided on this quotation throughout the installation. The site is free of any private utilities or underground items unless marked by owner. Any local labor requirements are by other. All items below are not included unless specifically stated on the quotation. Excessive rock excavation is not included in standard pricing. Proper site grade has been completed prior to the arrival of the installation crew. Additional mobilization costs will be charged for each trip if site is not ready for the installation of the equipment. Core drilling or saw cutting of existing or new concrete or asphalt is not included. The installation of all furnishings and equipment not indicated as surface mount or portable should be scheduled for installation prior to concrete or asphalt construction or blocked out for in concrete forms. Installation prices assume normal soil conditions, easy access to site with trucks. If it becomes necessary to cross landscaping, sidewalks, or grass areas to reach project area, re-seeding or sodding may be necessary - the customer will be responsible unless otherwise noted on quote. Installation does not include any allowance for moving or repairing any underground utility lines such as electrical, telephone, gas, water or sprinkler lines that may be encountered during installation operations. Any additional costs incurred as a result of hard rock conditions requiring extra equipment, or for utility removal or repair resulting in delay is for customer's account, unless they are detailed on as built site drawings or marked on the ground prior to quotation, fabrication and installation.

Owner/Contractor site preparation and installation notes and instructions:

- **OWNER/CONTRACTOR RESPONSIBILITY FOR GRASS AND TREE REMOVAL PRIOR TO INSTALLATION OF PLAYGROUND EQUIPMENT:**
- If site conditions become too wet to install equipment, drying agents such as lime can be applied at additional costs to be borne by Owner. The application of drying agents must be pre-approved via written instrument, signed by both Owner and Hutchinson Recreation & Design, before application begins.
- Any on-site installation, site work, or surfacing change orders must be pre-approved via written instrument, signed by Owner & Hutchinson Recreation & Design, Inc. before change orders are executed. Hutchinson Recreation & Design, Inc. is not responsible or liable for any verbal or other negotiations with installers made without approval and a signed change order from our office.
- Removal and replacement of existing surfacing materials is not included unless specifically indicated on the quotation.
- Owner is responsible for locating and marking all private utility locations and notification of any other underground items prior to quotation, fabrication, and installation. Hutchinson Recreation & Design will not be responsible for any underground items encountered or any damage to such items not marked or pointed out by the owner. Any delay or cost to repair as a result will be at an additional cost to the owner. If installation is included on quote public locates will be called out by the install company prior to install – NOT private locates.
- Quotations for Engineered Wood Fiber do not include gravel drainage systems; gravel sumps or daylight drains unless specifically noted on quote / bid.
- Required installation grade includes: Site excavated to proper depth and grade should be no greater than 2% for drainage. Owner/Contractor will provide safety/storage of equipment/security fencing until equipment and surfacing is ready for installation and use – unless specifically noted on quote as included by us.

Additional information regarding Safety Surfacing for Playground Projects:

- Purchaser shall be responsible for storage of all products and security, as needed, to prevent vandalism and/or damage of any type to the surface during installation process, curing time, and after the installation is completed. Surface quotes are based on thickness/critical fall heights performances as tested by an accredited laboratory, and are not subject to results generated by hand held, suspect field-testing equipment.
- Purchaser is responsible for storage of all resin, glue, and binder in a temperature controlled environment. Any materials left outside will be at the sole cost of the purchaser if replacement products are needed.
- If site is prepared by other and if the site is over the square foot agreed upon the customer will be charged for the additional square foot based on the critical fall height of equipment and price/square foot.
- Price excludes concrete, asphalt, site work, base aggregate, compaction or preparation etc.
- If customer or other is preparing the sub base for unitary surfacing, then customer or other is responsible to adhere to manufacturers sub base requirements/specifications and provide photo field verification to our office prior to scheduling of surfacing install crews. PLEASE NOTE: Lead times vary for the scheduling of the surfacing install crews at certain times of the year. Please check with our office for tentative scheduling dates at the time of order.
- If loose fill engineered wood fiber is being purchased customer is aware that: Due to the nature of wood fiber, wood fiber will vary in size and type of wood if purchased in differing time frames. Engineered Wood fiber surfacing is for safety purposes 1st and the aesthetic look and feel of the wood fiber is inconsistent. The variance will meet all required guidelines/specifications from the manufacturer.

Owner/Contractor delivery and receipt of shipment:

- Unloading is not included with installation unless specifically noted on the quote / bid.
- The Owner/Contractor will be notified 24 hours or more prior to delivery whenever possible.
- It is assumed that all materials can be delivered to the jobsite, and the Owner/Contractor will provide a secure location to store the equipment prior to installation. Installation price does not include transportation of materials from a secondary secure delivery location to job site.
- Delivery does not include lift-gate service-unless specifically noted on quote/bid. Those services, depending on product, may be available by request for an extra cost to the owner.
- Lead-times vary by manufacture and are subject to change without notice. Please ask our office at the time of order for approximate shipping lead times. Please provide firm shipment schedules at time of order, delivery dates requested outside of normal manufacturing days may be subject price increases from suppliers for materials and freight.

Insurance: This proposal contains standard General Liability and Workers Compensation coverage – when applicable. Any waivers of subrogation and primary non-contributory endorsement requirements require additional premium to the provider. Any additional such charges to our policies as a result of the awarding of a contract based upon this proposal will be passed through to you at your additional expense.

Quotation does NOT include the following (Unless specifically stated on the quotation / bid): taxes, prevailing wages, permits, local business license, state or local approvals, performance/payment bond, engineering seals, testing, site preparation, or storage of equipment, installation, supervision, removal of excess dirt from footings or any site excavation, borders, safety surfacing, unloading of equipment, security, fencing, custom colors on equipment or materials, or landscaping!

Order and Payment Terms: Any orders that are tax-exempt will require a copy of the tax-exempt certificate at the time of order. All applicable tax will be added to final invoice. Payment terms to be determined at the time of order. If applying for credit, unless credit is approved by Hutchinson Recreation & Design and/or Manufacturing Company, a 50% or 100% prepayment may be required. Cash in advance discounts available on certain equipment, NO retainage/retentions allowed. Quotation is valid for 21 days. Past due accounts will be assessed interest at the rate of 1.5% per month. Hutchinson Recreation & Design shall be entitled to recover its reasonable attorneys' fees and costs if legal action is brought to collect amounts due. Please Note: Due to the Global Pandemic our suppliers/partners are experiencing labor shortages, raw material shortages and disruptions in supply chains worldwide. Global production for factories worldwide has been significantly affected. Lead times are now approximate only. All orders are subject to delay. We appreciate your business and understanding.

Failure to comply with these terms and conditions will result in additional charges or contract change orders. Please contact our office with any questions concerning the attached quotation or terms and conditions, or if any additional services are required for your Project. Thank you for the opportunity to provide this quotation.

Poligon Products only:

1. Pricing assumes Risk Category II for all structures with roof coverings and Risk Category I for all other structures (e.g. trellis, portal, etc.) as well as Wind Exposure C and clear wind flow as defined by ASCE 7, unless noted otherwise.
2. Pricing assumes a 20' separation between any adjacent structure with an eave height equal to or greater than the eave height of this structure if the ground snow load is greater than 0 PSF to account for drifted snow, unless noted otherwise.
3. Pricing assumes standard size electrical cutouts, unless noted otherwise: 2-3/8" wide x 4" tall single gang cutouts in columns at 18" or 48" above finish grade or 3/4" diameter cutouts in roof framing members.
4. Quotation is based on Poligon's interpretation of any drawings or documentation provided at time of quote request.
5. Deviation of design from the supplied quote and preliminary drawing may result in price changes. All design changes should be submitted to Poligon for re-quoting purposes.
6. Poligon provides pricing and engineering for the most cost effective and efficient frame, meeting Poligon's design philosophy of hidden bolted connections (no field welding required).
7. If this quotation does not reference specific design elements that must be incorporated, please work with Hutchinson Recreation & Design to update the quotation as required (e.g. column sizes, column locations, roof pitch, etc.).
8. All member sizes are preliminary until the engineering package has been completed. Preliminary reaction forces and foundation sizing may be provided upon request and should be used for budget purposes only.

Acceptance of Quotation:

The undersigned, by its duly authorized representative hereby authorizes Hutchinson Recreation to have the manufacturer ship the equipment listed on the accompanying quote, and complete the specified tasks, for which the undersigned agrees to pay the total amount specified. The undersigned acknowledges that it has read and agreed to the Terms and Conditions. Payment terms to be determined at the time of order. Non-taxable customers must provide proper tax exemption certificate to manufacturer at time of order or tax will be added to final invoice.



Customer Acceptance Signature

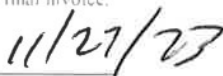

Date

Hutchinson Recreation & Design – PROPOSAL FACTS

PROPOSAL / QUOTE / BID (Items listed below are additional items available on certain products/services quoted. If these items are not listed as included or line itemed out on your quote then they are not included in your price of items quoted. If you would like pricing on any of these items added to your quote, please call our main office to inquire about availability.)

Unloading equipment	Lift gate services	Removal of excess material, dirt or old equipment from site	Concrete pad prices are (plus/minus) one-degree grade
Site Work	Drainage	Site Restoration	Installation of equipment
Safety Surfacing (Wood Fiber, Poured in Place, Tile, etc.)	Installation of safety surface	Any extra material/labor necessary to get grade is additional costs	Trash Dumpster
Taxes	Supervision	Fencing or Landscaping	Performance and Payment Bonds
Storage	Security	Testing/Permits/State or Local Approvals/Engineering Seals	Engineered Drawings & Calcs

NOTE: INSTALLATION QUOTE IS BASED ON "NORMAL" MISSOURI / ILLINOIS SOIL AND OR WATER TABLE CONDITIONS AND LEVELS. SEE TERMS SHEET FOR MORE INFORMATION ON INSTALLATION LIMITATIONS AND CUSTOMER RESPONSIBILITIES. ALL SUPERVISIONS WILL BE BILLED DIRECT BY AN INDEPENDENT SUPERVISOR.

OWNER SITE PREPARATION AND INSTALLATION NOTES:

Owner **MUST** provide safety fencing to be used around the site by the installer – unless specifically noted on our quote / bid.
 Desired install grade includes: sod removal flat/level surface w/drainage.
FOR PLAYGROUND PROJECTS - DO NOT SPREAD SAFETY SURFACE PRIOR TO EQUIPMENT INSTALLATION.
READ installation specifications brochures prior to installation.
 Install equipment according to manufacturer's specifications.
 You **MUST** call underground utilities prior to excavation – public and private lines. Public lines will be called out prior to install by us if installation is included on quote. All private lines must be marked by other with or without install options chosen.

DELIVERY INFORMATION:

Delivery day assistance needed to unload - the driver will be either a factory representative who may assist you or commercial carrier depending on manufacture. Depending on manufacture and equipment it will take anywhere between 2-5 sturdy people to unload equipment. Shelters, and some bigger equipment may require use of machinery to assist in the unloading of equipment. The cost of that machinery is not included in our pricing unless specifically noted on the quotation or bid. Lift gate services may be available upon request, this would be at an additional cost to the owner. Delivery point should be close to construction site - in secured area. Equipment should be inventoried carefully after unloading, along with notations of any discrepancies. **NOTE: MISSING PARTS CLAIMED AFTER 48 HOURS FROM THE DATE OF DELIVERY WILL NOT BE HONORED. MISSING PARTS NOTIFIED TO US AFTER 48 HOURS WILL REQUIRE RE-PURCHASE OF PARTS.**

CUSTOMER RESPONSIBILITY FOR PLAYGROUND PROJECTS:

During installation and at the completed installation or installation sign-off, the owner becomes responsible for keeping children off of the playground for 72 hours to allow cement to set up. If poured-in-place surfacing is installed the owner is responsible to keep children off to allow for the surfacing to properly cure – which may be up to 72 hours. It is advised to have security throughout the poured-in-place surfacing installation and during this curing process to prevent damage to the surfacing. It is the owner's responsibility to maintain the safety surfacing and schedule regular safety and maintenance inspections of the equipment.

INDEMNIFICATION:

HUTCHINSON RECREATION & DESIGN MAKES NO EQUIPMENT WARRANTIES EXCEPT FOR THOSE STANDARD WARRANTIES ISSUED WITH THE EQUIPMENT DIRECT FROM THE MANUFACTURER, WHICH ARE INCORPORATED HEREIN BY THIS REFERENCE. HUTCHINSON RECREATION & DESIGN SPECIFICALLY DISCLAIMS ANY IMPLIED WARRANTY OF MERCHANTABILITY OR FITNESS FOR A PARTICULAR PURPOSE AND ANY LIABILITY FOR INCIDENTAL OR CONSEQUENTIAL DAMAGES. CUSTOMER AGREES TO DEFEND, INDEMNIFY AND SAVE HUTCHINSON RECREATION & DESIGN AND

IT'S PRODUCT MANUFACTURERS HARMLESS FROM ALL CLAIMS OF ANY KIND FOR DAMAGES OF ANY KIND ARISING OUT OF CUSTOMER'S ALTERATION OF THE EQUIPMENT (WITHOUT THE MANUFACTURERS' EXPRESS WRITTEN CONSENT), ITS FAILURE TO MAINTAIN THE EQUIPMENT, ITS FAILURE TO PROPERLY FOLLOW THE RESPECTIVE MANUFACTURERS' INSTALLATION INSTRUCTIONS, ITS FAILURE TO PROPERLY SUPERVISE EQUIPMENT USE. FOR PLAYGROUND EQUIPMENT THEIR FAILURE TO PROVIDE AND MAINTAIN APPROPRIATE TYPES AND DEPTHS OF SAFETY SURFACING BENEATH AND AROUND THE EQUIPMENT IN ACCORDANCE WITH THE RESPECTIVE MANUFACTURERS' INSTALLATION AND OWNER'S MANUALS AND THE MOST CURRENT CONSUMER PRODUCT SAFETY COMMISSION HANDBOOK FOR PUBLIC PLAYGROUND SAFETY.

PLEASE NOTE:

For playground projects, to the best of our knowledge, the proposed components/parts bring your play structure into compliance with current guidelines and standards. If it is determined at a later date that additional components/parts are required there will be an additional cost for these components/parts. The proposed equipment from the manufacturer meets applicable federal guidelines and is not ensured to meet specific state and local codes.

For shelters and shades with engineered drawings / calcs included will be engineered to meet local IBC codes.

For all projects the customer is responsible, if applicable, to bring any concerns for state and local codes to the attention of Hutchinson Recreation & Design prior to quotation, ordering, and installation of equipment – otherwise any additional costs incurred will be the full responsibility of the owner.

NOTICE TO OWNER

FAILURE OF THIS CONTRACTOR TO PAY THOSE PERSONS SUPPLYING MATERIAL OR SERVICES TO COMPLETE THIS CONTRACT CAN RESULT IN THE FILING OF A MECHANIC'S LIEN ON THE PROPERTY WHICH IS THE SUBJECT OF THIS CONTRACT PURSUANT TO CHAPTER 429, RSMO. TO AVOID THIS RESULT YOU MAY ASK THIS CONTRACTOR FOR "LIEN WAIVERS" FROM ALL PERSONS SUPPLYING MATERIAL OR SERVICES FOR THE WORK DESCRIBED IN THIS CONTRACT. FAILURE TO SECURE LIEN WAIVERS MAY RESULT IN YOUR PAYING FOR LABOR AND MATERIAL TWICE.

Pandemic:

The current COVID-19 pandemic has created uncertainty on how business will be able to be conducted in the near future based on quarantines, closures, shortages & availability of resources such as materials & labor workforce. Customer & Contractor agree to work together with best efforts to complete the work covered in this agreement as best and fast as possible without being penalized as long as there's active disruptions & limitations caused from the current pandemic.

PRODUCT INFORMATION:

PLEASE VISIT OUR WEBSITE AT WWW.HUTCHINSON-RECREATION.COM AND CLICK ON THE MANUFACTURERS WEBSITE LINKS FOR UP TO DATE PRODUCT INFORMATION, PRODUCT WARRANTIES, INSTALLATION INFORMATION. IF YOU WOULD LIKE ANY COPIES SENT TO YOU VIA EMAIL OR MAIL PLEASE CONTACT OUR MAIN OFFICE.

Acceptance of Proposal Facts and Conditions:

The undersigned acknowledges that it has read and agreed to the proposal facts.

Customer Acceptance Signature

11/27/23
Date

FOR KIDS AGES
2-5
YEARS

AGE GROUP: 2-5
ELEVATED PLAY ACTIVITIES - TOTAL: 3
ELEVATED PLAY ACTIVITIES ACCESSIBLE BY TRANSFER: 3 RECD 2
ELEVATED PLAY ACTIVITIES ACCESSIBLE BY RAMP: 0 RECD 0
GROUND LEVEL ACTIVITY TYPE: 2 RECD 1
GROUND LEVEL ACTIVITY QUANTITY: 2 RECD 1

Berkeley Parks - Opt A Berkeley, MO

FOR KIDS AGES
5-12
YEARS

AGE GROUP: 5-12
ELEVATED PLAY ACTIVITIES - TOTAL: 4
ELEVATED PLAY ACTIVITIES ACCESSIBLE BY TRANSFER: 4 RECD 2
ELEVATED PLAY ACTIVITIES ACCESSIBLE BY RAMP: 0 RECD 0
GROUND LEVEL ACTIVITY TYPE: 4 RECD 1
GROUND LEVEL ACTIVITY QUANTITY: 8 RECD 1

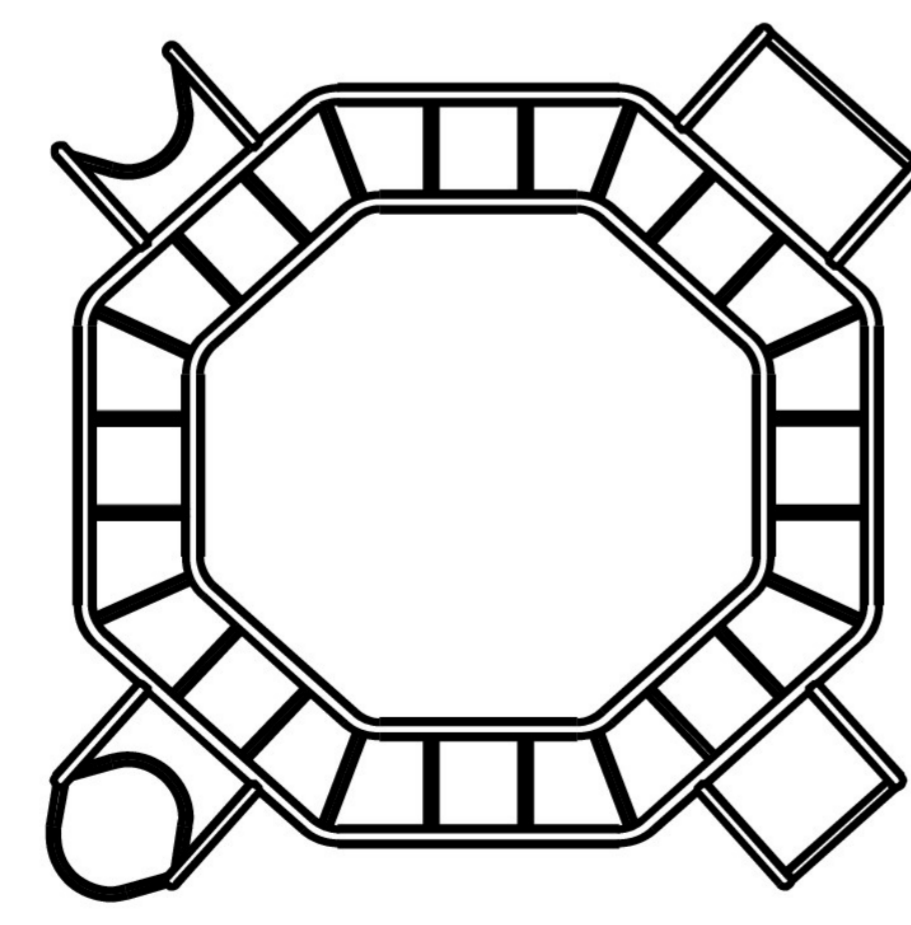

TARANTULA CLIMBER
4561

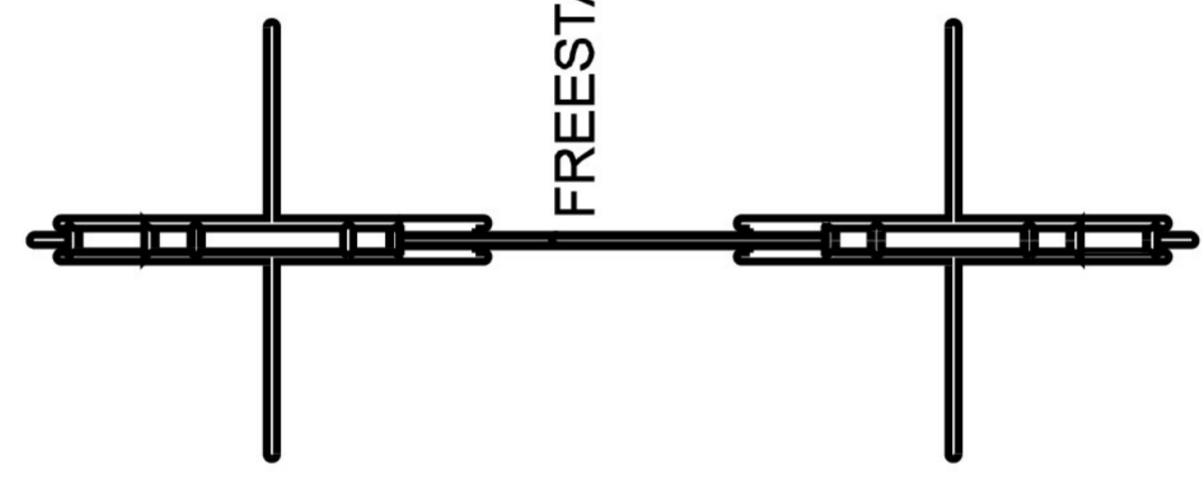

FREESTANDING HEX CLIMBER
4651

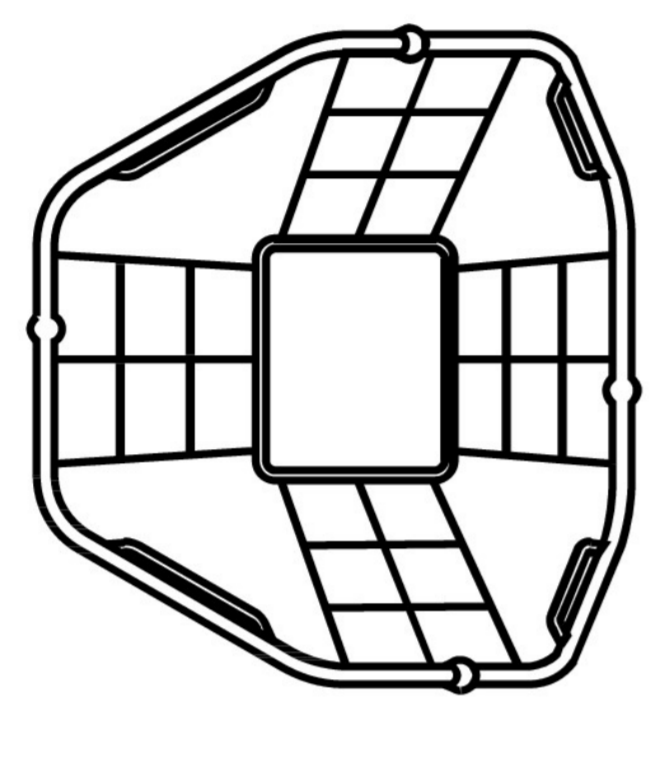

ANGLED HYPERBOLIX
4642

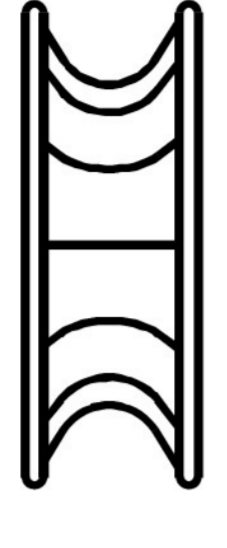

CAMEL BACK CLIMBER
4481

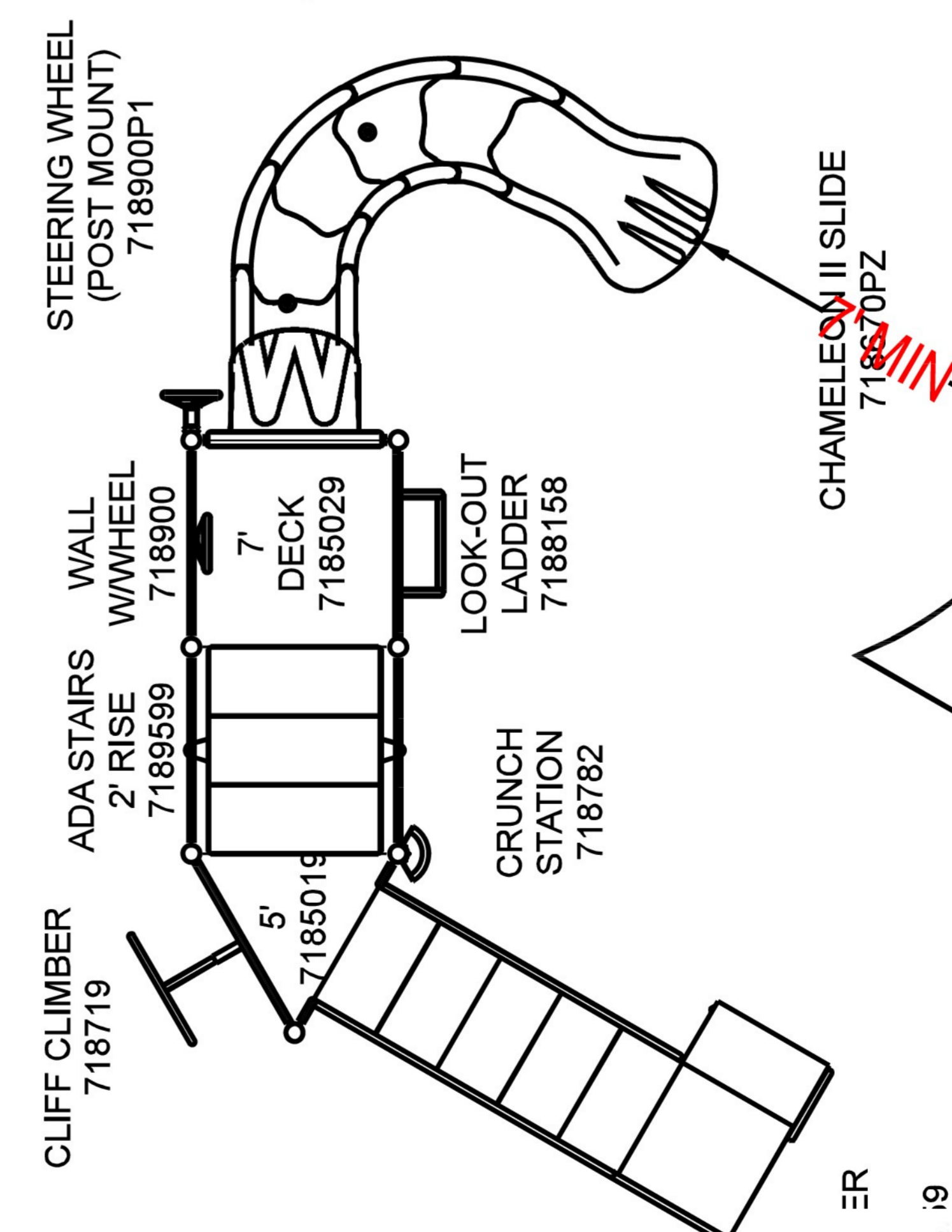

CLIFF CLIMBER
718719

SIDE-BY-SIDE SLIDE
718700

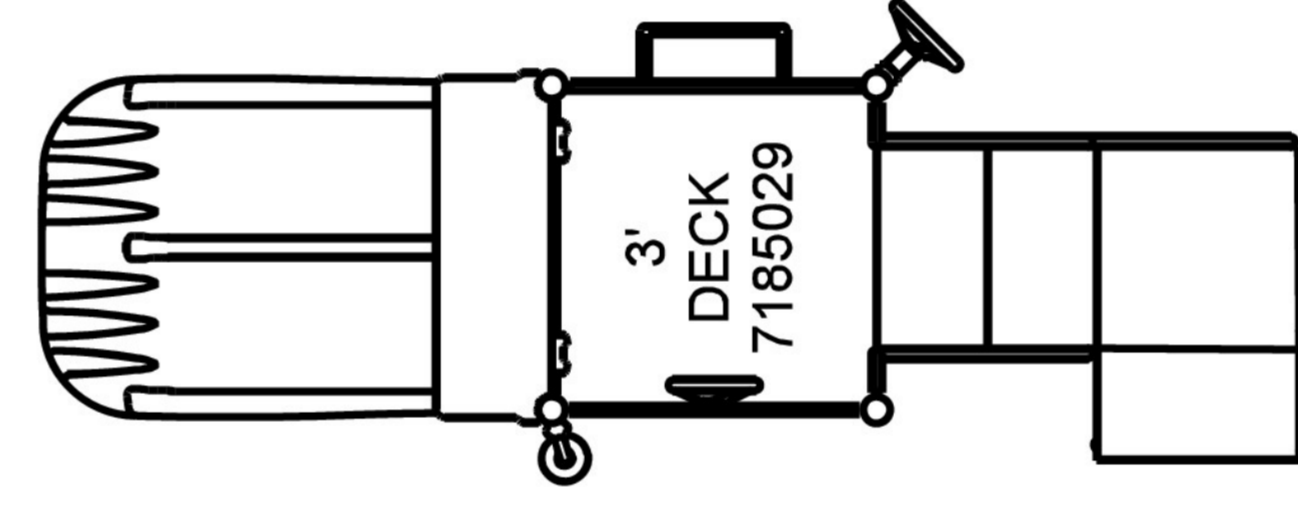

BELL
718796P1

VERTICAL LADDER
7188153

STEERING WHEEL (POST MOUNT)
718900P1

TRANSFER POINT
71885139

CHAMELEON II SLIDE
7186702

STEERING WHEEL (POST MOUNT)
718900P1

CHAMELEON II SLIDE
718670PZ

ADA STAIRS
7189599

WALL W/WHEEL
718900

DECK
7185029

LOOK-OUT LADDER
7188158

CRUNCH STATION
718782



To verify product certification, visit www.ipema.org



HUTCHINSON RECREATION & DESIGN
1000 EDGEWATER PT STE 101 PHONE NO: (314) 436-5000
LAKE SAINT LOUIS, MO FAX NO: (314) 332-2877

GROUND SPACE: 68'-6" x 36'-6"
PROTECTIVE AREA: 85'-0" x 49'-0"

DRAWN BY: Brad Hutchinson

DATE: 10/5/23

R0043_45216547097

COMPLIES TO ASTM/CPSC

COMPLIES TO ADA

THE PLAY COMPONENTS IDENTIFIED IN THIS PLAN ARE IPEMA CERTIFIED. THE USE AND LAYOUT OF THESE COMPONENTS CONFORM TO THE REQUIREMENTS OF ASTM F1487.

AN ENERGY ABSORBING PROTECTIVE SURFACE IS REQUIRED UNDER & AROUND ALL PLAY SYSTEMS

To promote safe and proper equipment use by children, Miracle recommends the installation of either a Miracle safety sign or other appropriate safety signage near each play system's main entry point(s) to inform parents and supervisors of the age appropriateness of the playsystem and general rules for safe play.

Reverse View

Anti-Microbial Paint Options
Available at No Extra Cost

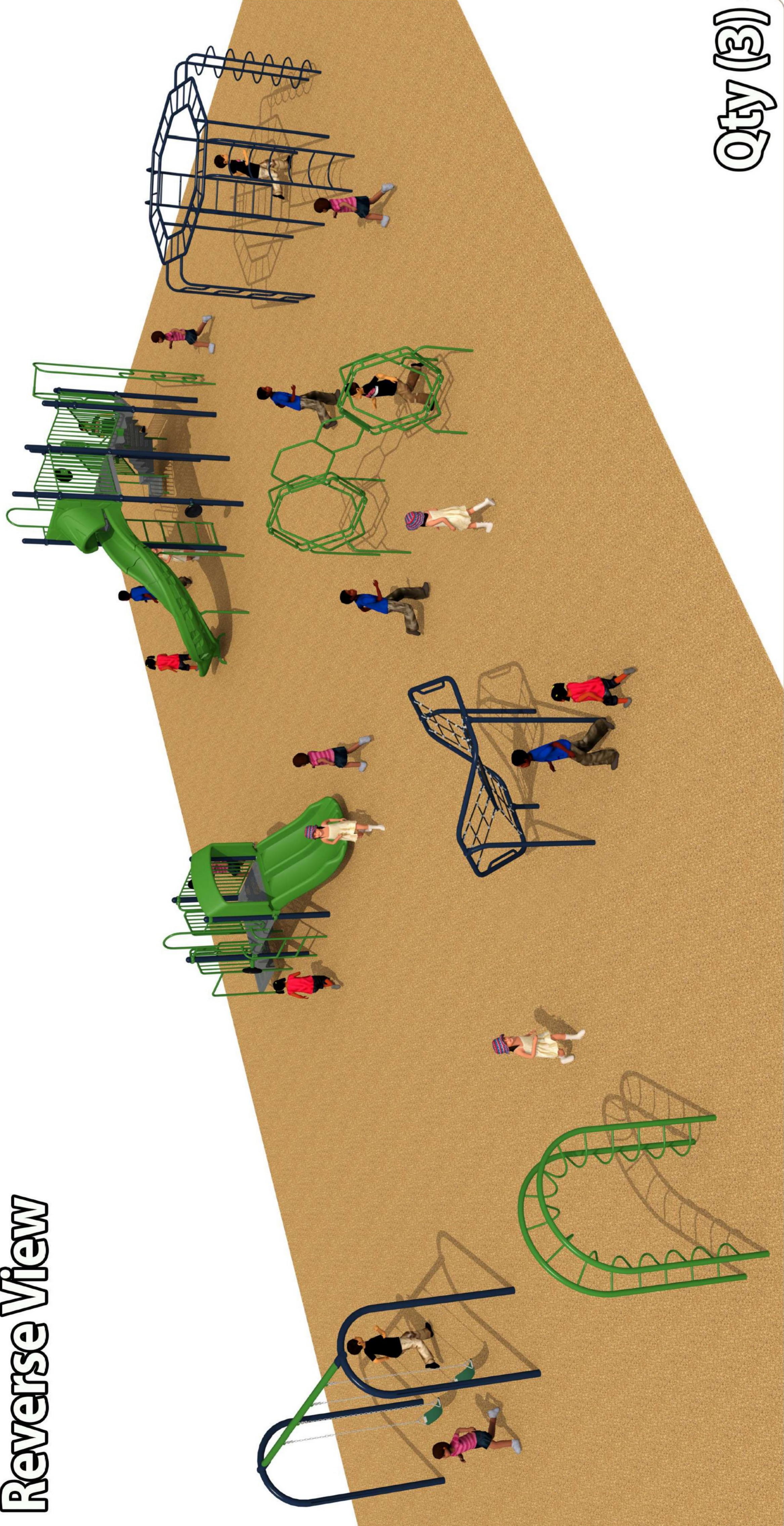

*Additional views in paperwork

Qty (3) - Tarantula

Climber



Qty (3) - Age 5-12
System

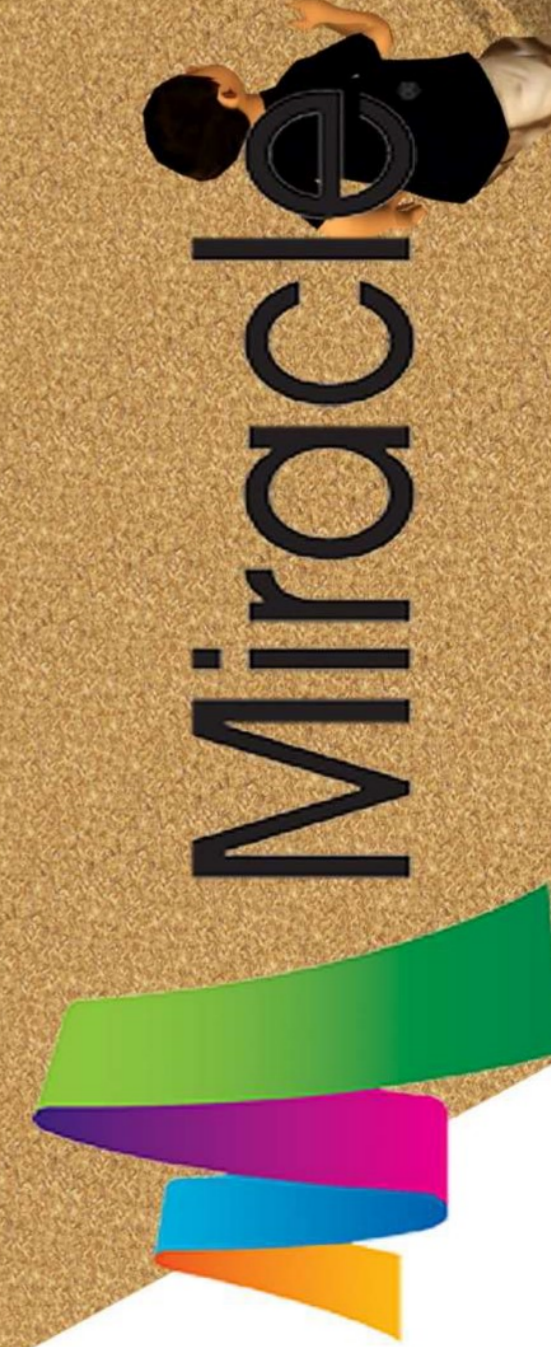

Final Colors TBD

This is only a picture actual equipment color and surfacing layout may vary.

Qty (3) - Camel Back
Climber

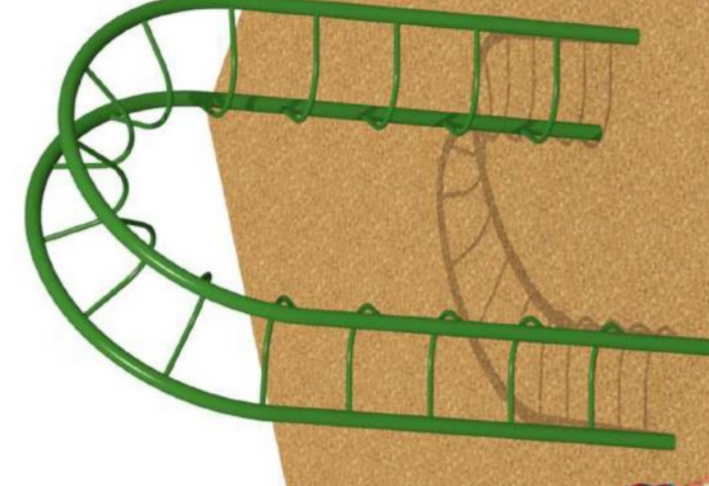

Qty (3) - Hyperbolix

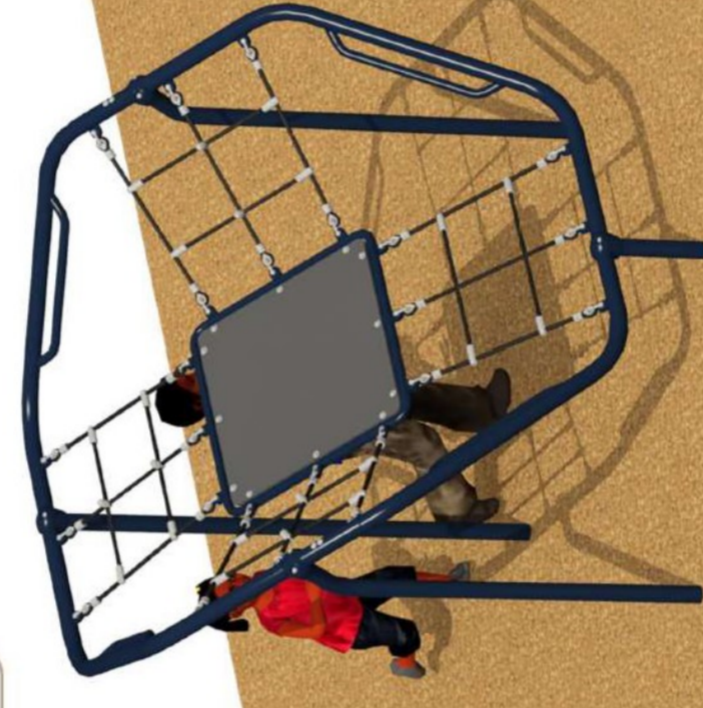

Qty (3) - Hex Climber

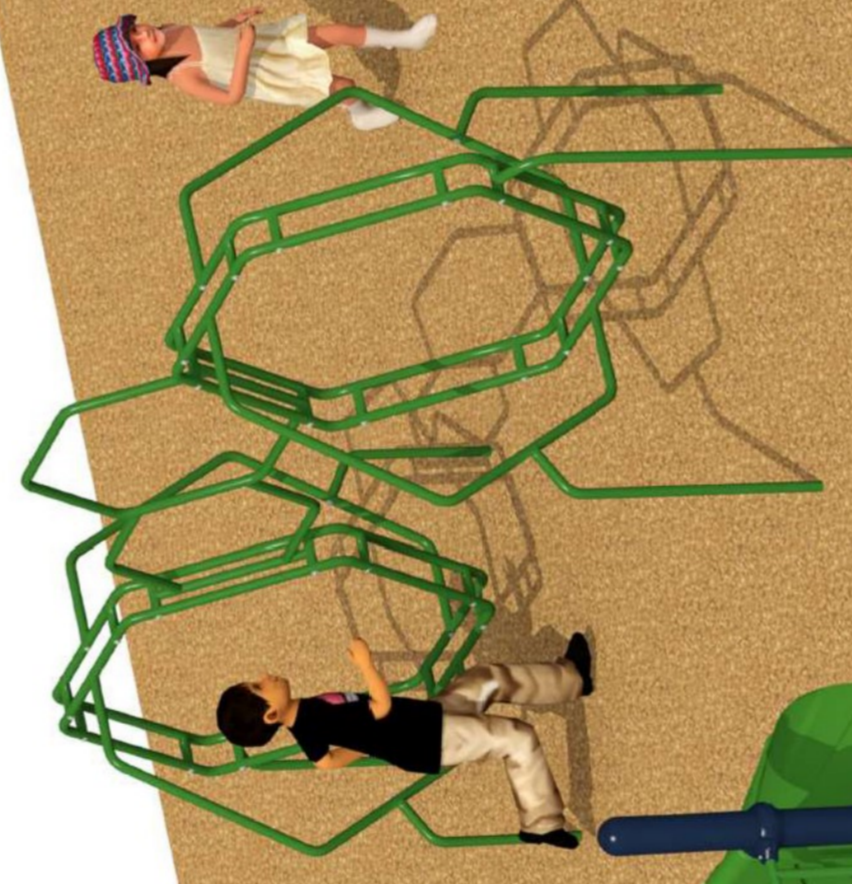

Qty (2) - Age 2-5
System

Qty (2) - Swing



Made in



Missouri

Berkeley Parks
Option A

Hutchinson Recreation & Design
Ph: (800) 848.5616 - www.hutchinson-recreation.com

